

DOOSAN INFRACORE GENERATOR ENGINE

DP180LA

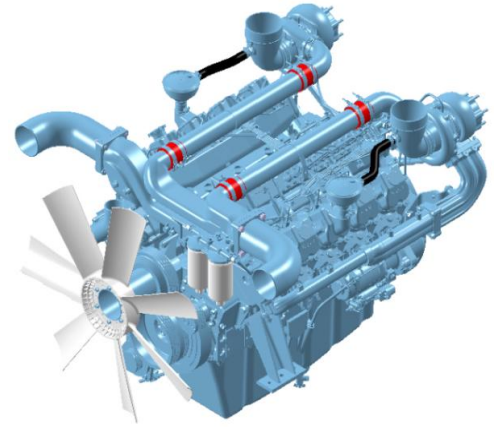

Ratings (kWm/PS)	Gross Engine Output - without Cooling Fan		Net Engine Output - with Cooling Fan	
	Standby	Prime	Standby	Prime
1500rpm(50Hz)	552/750	502/683	536/729	486/661
1800rpm(60Hz)	615/836	559/760	591/804	535/727

* 50Hz : DP180LAF, 60Hz : DP180LAS

Ratings Definitions

The power ratings of Emergency Standby and Prime are in accordance with ISO 8528.

Fuel Stop power in accordance with ISO 3046.

Electric power(kWe) should be estimated by considering generator efficiency, cooling fan power loss and power derating due to altitude and ambient temperature.

STANDBY POWER RATING is applicable for supplying emergency power for the duration of the utility power outage.

No overload capability is available for this rating. A standby rated engine should be sized for a maximum of an 70% average load factor and 200 hours of operation per year. This includes less than 25 hours per year at the Standby Power rating.

PRIME POWER RATING is available for an unlimited of hours per year in variable load application. Variable load should not exceed a 70% average of the Prime Power rating during any operating period of 24 hours. The Total operating time at 100% Prime Power shall not exceed 500 hours per year. A 10% overload capability is available for a period of 1 hour within a 12 hour period of operation. Total operating time at the 10% overload power shall not exceed 25 hours per year.

◎ GENERAL ENGINE DATA

○ Engine Model	DP180LA
○ Engine Type	4-Cycle, V-type, 10-Cylinder, Turbo charged & intercooled (air to air)
○ Bore x stroke	128 x 142 mm
○ Displacement	18.273 liters
○ Compression ratio	15 : 1
○ Rotation	Counter clockwise viewed from Flywheel
○ Firing order	1-6-5-10-2-7-3-8-4-9
○ Injection timing	21°±1° BTDC @ 1800 rpm, 19°±1° BTDC @ 1500 rpm,
○ Dry weight	1,250 kg(with Fan)
○ Dimension (LxWxH)	1,594 x 1,389 x 1,223 mm
○ Fly wheel housing	SAE NO.1M
○ Fly wheel	Clutch NO.14M
○ Number of teeth on flywheel	160

◎ ENGINE MOUNTING

○ Maximum Bending Moment at Rear Face to Block	1,325 N.m
--	-----------

◎ EXHAUST SYSTEM

○ Maximum Back Pressure	5.9 kPa
-------------------------	---------

◎ AIR INDUCTION SYSTEM

○ Maximum Intake Air Restriction	
. With Clean Filter Element	2.16 kPa
. With Dirty Filter Element	6.23 kPa
○ Max. static pressure after Radiator	0.125 kPa

◎ COOLING SYSTEM

Water circulation by centrifugal pump on engine.

○ Cooling method	Fresh water forced circulation
○ Coolant capacity	Engine Only : Approx. 21 lit, With Radiator(*Air On 43°C) : Approx 91 lit.
○ Coolant flow rate	660 liters / min @ 1800 rpm, 550 liters / min @ 1500 rpm
○ Pressure Cap	Max. 49 kPa
○ Water Temperature	
- Maximum for standby and Prime	103°C
- Before start of full load	40.0°C
○ Water pump	Centrifugal type driven by belt
○ Thermostat Type and Range	Wax – pellet type, Opening temp. 71°C , Full open temp. 85°C
○ Cooling fan	Blower type, plastic , 915 mm diameter, 7 blades
○ Max. external coolant system restriction	Not available

* Two radiator options are provided, based on allowable maximum Air temperature On radiator inlet (Air On) : Air On 43°C / Air On 52°C
- ATB(Ambient Temperature before Boiling) of generator set varies depending on the engine room ventilation design, even if the same radiator applied.
Adequate selection of radiator options by means of the cooling test is highly recommended, and generator set makers are responsible for the selection.

◎ LUBRICATION SYSTEM

Force-feed lubrication by gear pump, lubricating oil cooling in cooling water circuit of engine.

○ Lub. Method	Fully forced pressure feed type
○ Oil pump	Gear type driven by crank-shaft gear
○ Oil filter	Full flow, cartridge type
○ Oil capacity	Max. 34 liters , Min. 23 liters
○ Lub oil pressure	Idle Speed : Min 100 kPa Governed Speed : Min 250 kPa
○ Maximum oil temperature	120°C
○ Angularity limit	Front down 10 deg , Front up 10 deg , Side to side 22.5 deg
○ Lubrication oil	Refer to Operation Manual

◎ FUEL SYSTEM

Bosch type in-line pump with integrated, electromagnetic actuator.

○ Injection pump	Bosch in-line "P" type
○ Governor	Electric type
○ Speed drop	G3 Class (ISO 8528)
○ Feed pump	Mechanical type in injpump.
○ Injection nozzle	Multi hole type
○ Opening pressure	28 MPa
○ Fuel filter	Full flow, cartridge type with water drain valve.
○ Maximum fuel inlet restriction	30 kPa
○ Maximum fuel return restriction	60 kPa
○ Fuel feed pump Capacity	630 liters / hr
○ Used fuel	Diesel fuel oil

◎ ELECTRICAL SYSTEM

○ Battery Charging Alternator	27.5V x 45A alternator
○ Voltage regulator	Built-in type IC regulator
○ Starting motor	24V x 7.0 kW
○ Battery Voltage	24V
○ Battery Capacity	2 x 200 Ah (recommended)
○ Starting aid (Option)	Block heater

◎ VALVE SYSTEM

○ Type	Overhead valve type	
○ Number of valve	Intake 1, exhaust 1 per cylinder	
○ Valve lashes at cold	Intake 0.25 mm , Exhaust 0.35 mm	
○ Valve timing	Opening	Close
- . Intake valve	24 deg. BTDC	36 deg. ABDC
- . Exhaust valve	63 deg. BBDC	27 deg. ATDC

◎ PERFORMANCE DATA

		Prime Power		Standby Power	
○ Governed Engine speed	rpm	1500	1800	1500	1800
○ Engine Idle Speed	rpm	800	800	800	800
○ Over speed limit	rpm	1650	1980	1650	1980
○ Gross Engine Power Output	kW	502	559	552	615
	PS	682	760	750	836
○ Break Mean effective pressure	MPa	2.20	2.04	2.42	2.24
○ Mean Piston Speed	m/s	7.1	8.5	7.1	8.5
○ Friction Power	kW	40	55	40	55
	PS	54.4	74.8	54.4	74.8
○ Specific fuel consumption					
25% load	liters/hr	35.4	38.6	38.3	42.0
50% load	liters/hr	64.8	72.6	70.7	79.4
75% load	liters/hr	94.2	106.6	103.0	116.7
100% load	liters/hr	123.6	140.5	135.4	154.1
○ Maximum Lube oil consumption	g/h	477	532	525	585
○ Fan Power	kW	16	24	16	24
○ Sound Pressure at 1m from the each side of Cylinder Block					
(without Fan)	dB(A)	98.65	101.03	98.65	101.03

The all data and the specific fuel consumption are based on ISO 3046/1, Standard reference conditions are in accordance with 298 K(25° Celsius) air temperature, 100kPa(1000mbar) air pressure, 60% relative humidity, 110m(361ft) altitude.

◎ Engine Data with Dry Type Exhaust Manifold

○ Intake Air Flow	m ³ /min	30.9	40.1	33.2	43.0
○ Exhaust gas temp. after turbo.	°C	540	501	562	523
○ Exhaust Gas Flow	m ³ /min	96	118	106	130
○ Heat Rejection to Exhaust	kW	464	527	508	578
○ Heat Rejection to Coolant	kW	222	252	243	276
○ Heat Rejection to Intercooler	kW	113	128	124	141
○ Radiated Heat to Ambient	kW	47	53	52	59
○ Cooling water circulation	liters/min	590	660	590	660
○ Cooling fan air flow	m ³ /min	700	850	700	850

◎ DERATING FROM ISO 3046 STANDARD CONDITIONS

The maximum power is the STANDBY rating when assessing derate parameters.

Ambient temperature is air inlet temperature.

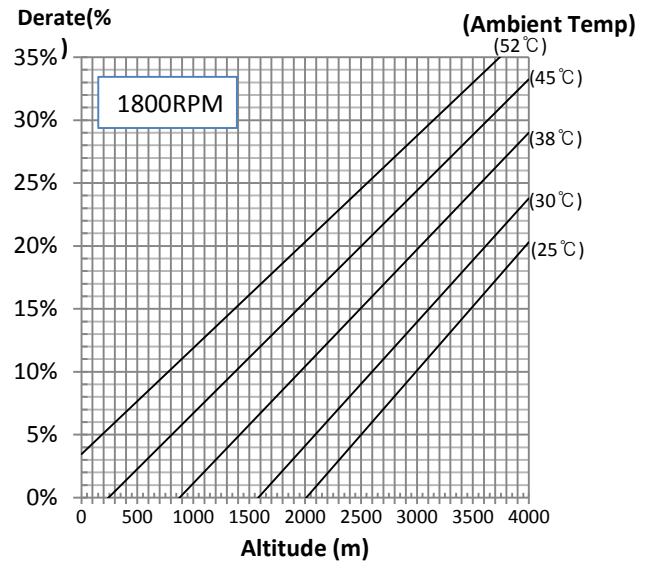
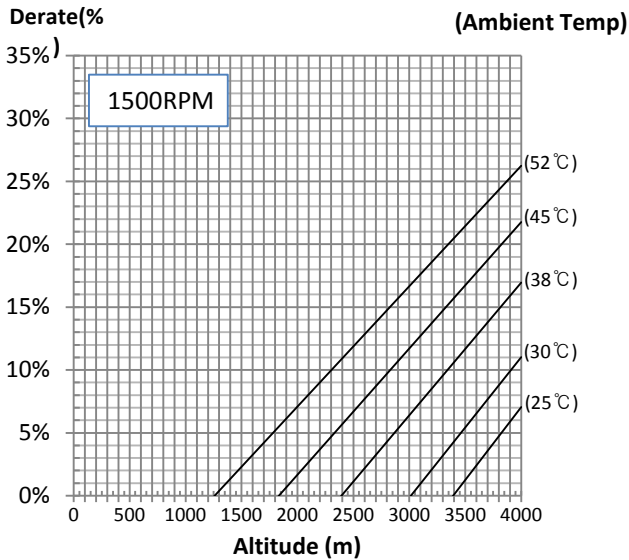

◎ ENGINE DIMENSION

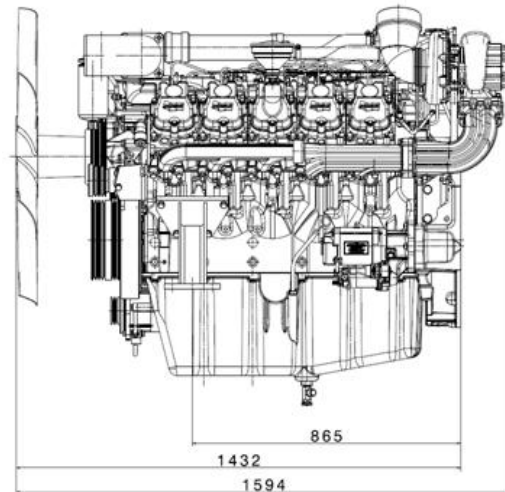
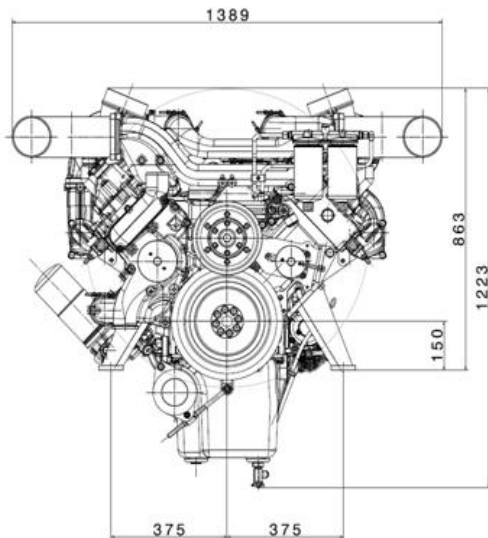

◆ CONVERSION TABLE

in. = mm x 0.0394

PS = kW x 1.3596

psi = kg/cm² x 14.2233

in³ = lit. x 61.02

hp = PS x 0.98635

lb = kg x 2.20462

kW = kcal/sec x 0.239

lb/ft = N.m x 0.737

U.S. gal = lit. x 0.264

kW = 0.2388 kcal/s

lb/PS.h = g/kW.h x 0.00162

cfm = m³/min x 35.336

MPa = kPa x 1000 = bar x 10

Doosan Infracore Co., Ltd.

21st Floor, Doosan Tower, 18-12, Euljiro 6-ga,
Jung-gu, Seoul, Korea.

TEL : +82-2-3398-8578 / FAX : +82-2-3398-8509

E-mail : enginesales@doosan.com

Web site : www.doosaninfracore.com

※ Specifications are subject to change without prior notice.